

NX-P1200NV
NX-P1200AV
NX-P1202AV
NX-P1300NU
NX-P1300AU
NX-P1302AU

USER MANUAL

ProTalk DIGITAL
ProTalk



JVCKENWOOD Corporation

CONTENTS

MODELS COVERED BY THIS MANUAL	4
PREPARATION	5
INSTALLING THE ANTENNA	5
INSTALLING/ REMOVING THE BATTERY PACK.....	5
INSTALLING THE BELT CLIP	6
INSTALLING THE CAP OVER THE SPEAKER/ MICROPHONE JACKS.....	6
INSTALLING THE SPEAKER/ MICROPHONE OR HEADSET	7
ORIENTATION	8
BASIC OPERATION	9
POWER ON	9
ADJUST THE VOLUME	9
SELECT A ZONE.....	9
SELECT A CHANNEL	9
MAKE A CALL	9
RECEIVE VOICE	10
POWER OFF	10
LED Indicator Status	10
SELF-PROGRAMMING MODE	11
SELF-PROGRAMMING FLOW.....	11
DEFAULT CHANNEL SETTINGS	13
ID SETUP	19
NXDN ID Setup (Digital).....	19
Reserved Group Setup (Digital)	20
ZONE SELECTION.....	22
CHANNEL SETUP	23
Frequency Setup	23
Channel Type Setup	26
TX Setup	27
QT/DQT Setup (Analog).....	29
RAN Setup (Digital)	32
TX Power Setup.....	33
CHANNEL CONFIRMATION MODE	34
BUTTON FUNCTION PROGRAMMING MODE	35
FUNCTIONS LIST	35
PROGRAMMABLE FUNCTIONS	37
Button Lock	37
Calling Alert.....	37
External Speaker.....	37

Home Channel	38
Home Channel Select	38
Individual Reply	39
Low Transmit Power.....	40
Monitor	40
Monitor Momentary	40
Scan	40
Scan Temporary Delete	40
Scrambler/ Encryption	41
Speaker Attenuation	41
Squelch Off.....	41
Squelch Off Momentary.....	41
Super Lock	42
Zone Down	42
Zone Up.....	42
Channel Down	42
Channel Up	42
OTHER PROGRAM FUNCTIONS	43
SECOND PTT	43
CW MESSAGE	43
FIXED VOLUME.....	43
RX/TX FREQUENCY SCAN.....	43
ZONE SELECT	43
VOICE OPERATED TRANSMISSION (VOX).....	44
VOX Type.....	44
VOX Function Setup	44
VOX Operation	45
Semi-VOX Operation	45
BACKGROUND OPERATIONS	46
TIME-OUT TIMER (TOT)	46
BATTERY SAVER	46
LOW BATTERY WARNING.....	46
BUSY CHANNEL LOCKOUT (BCL)	46
VOICE ANNOUNCEMENT	47
ALL RESET MODE.....	48
TROUBLESHOOTING GUIDE.....	49
SPECIFICATIONS.....	50

MODELS COVERED BY THIS MANUAL

The models listed below are covered by this manual:

ProTalk DIGITAL

NXDN/ Analog Transceiver

NX-P1200NV : VHF TRANSCEIVER

NX-P1300NU : UHF TRANSCEIVER

ProTalk

Analog Transceiver

NX-P1200AV : VHF TRANSCEIVER

NX-P1202AV : VHF TRANSCEIVER

NX-P1300AU : UHF TRANSCEIVER

NX-P1302AU : UHF TRANSCEIVER

PREPARATION

INSTALLING THE ANTENNA

Screw the antenna into the connector on the top of the transceiver by holding the antenna at its base and turning it clockwise until secure.

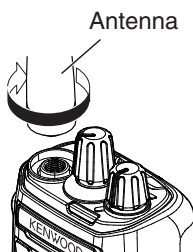

INSTALLING/ REMOVING THE BATTERY PACK

The battery pack is not charged at the factory; charge it before use.



CAUTION

- ◆ Do not short the battery terminals or dispose of the battery by fire.
- ◆ Never attempt to remove the casing from the battery pack.

1 Align the battery pack with the back of the transceiver, then press the battery pack and transceiver firmly together until the release latch on the base of the transceiver locks.

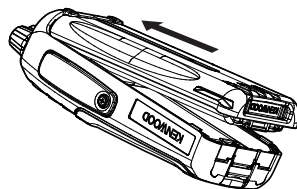

2 To remove the battery pack, lift the safety catch on the base of the transceiver, then press the release latch underneath the safety catch.

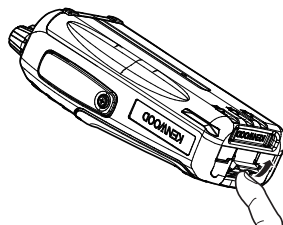

3 While pressing the release latch, pull the battery pack away from the transceiver.

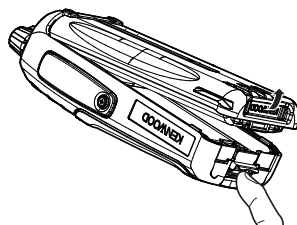

INSTALLING THE BELT CLIP

If necessary, attach the belt clip using the two supplied M3 x 8 mm binding screws.

Note:

- ◆ If the belt clip is not installed, its mounting location may get hot during continuous transmission or when left sitting in a hot environment.
 - ◆ Use the Phillips #2 screwdriver.
-

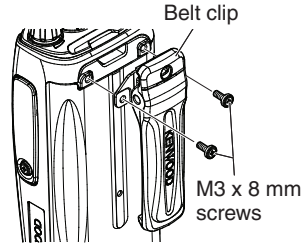

CAUTION

- ◆ Do not use glue which is designed to prevent screw loosening when installing the belt clip, as it may cause damage to the transceiver. Acrylic ester, which is contained in these glues, may crack the transceiver's back panel.

INSTALLING THE CAP OVER THE SPEAKER/ MICROPHONE JACKS

Note:

- ◆ For the speaker/ microphone jack, waterproof performance is guaranteed by securing the supplied cap. Waterproof performance will not be guaranteed by connecting an optional speaker/ microphone, etc.
 - ◆ Use the Phillips #1 screwdriver.
-

- 1 If you are not using an optional speaker/ microphone or headset, install the cap over the speaker/ microphone jacks.
- 2 Secure the cap in place using the attached screw.

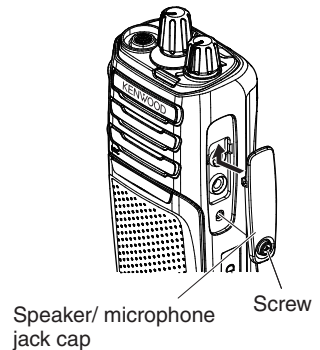

INSTALLING THE SPEAKER/ MICROPHONE OR HEADSET

Note:

- ◆ The transceiver is not fully water resistant when using a speaker/ microphone or headset.
 - ◆ Use the Phillips #1 screwdriver.
-

- 1 Insert the speaker/ microphone plugs into the speaker/ microphone jacks of the transceiver.
- 2 Place the locking bracket over the speaker/ microphone plugs so that the locking tabs insert into the transceiver grooves.
- 3 Secure the locking bracket in place using the attached screw.

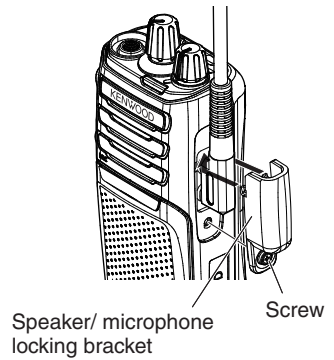

ORIENTATION

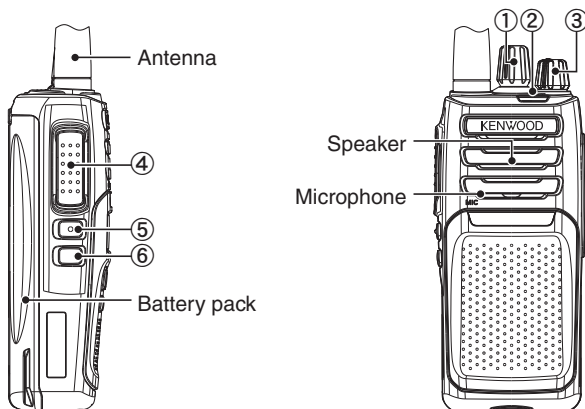

① Selector

Rotate to change the operating channel.

② LED indicator

Refer to the “LED Indicator Status” {p. 10}.

③ Power switch/ Volume control

Turn clockwise to switch the transceiver ON. To switch the transceiver OFF, turn counterclockwise until a click sounds. Rotate to adjust the volume level.

④ PTT (Push to Talk) switch

Press and hold, then speak into the microphone to transmit.

⑤ Side 1 button

Press to activate its programmable function.

Default Function	
Press	None (No function)
Press and hold	Zone Up

- For function descriptions and details on how to change the function of the **Side 1** button, refer to “BUTTON FUNCTION PROGRAMMING MODE” {p. 35}.

⑥ Side 2 button

Press to activate its programmable function.

Default Function	
Press	None (No function)
Press and hold	Zone Down

- For function descriptions and details on how to change the function of the **Side 2** button, refer to “BUTTON FUNCTION PROGRAMMING MODE” {p. 35}.

BASIC OPERATION

POWER ON

Turn the **Power** switch/ **Volume** control clockwise to switch the transceiver power ON.

- Power-on tone will sound.



ADJUST THE VOLUME

Rotate the **Power** switch/ **Volume** control to adjust the volume.

- Clockwise increases the volume and counterclockwise decreases the volume.

Note:

- ◆ To adjust the volume using background noise as a reference in Analog mode, use the **[Monitor]** or **[Squelch Off]** function.

SELECT A ZONE

Press and hold the **Side 1** button for 1 second to increase the Zone number (Zone 1→Zone 2→Zone 3→Zone 4→Zone 1).

Press and hold the **Side 2** button for 1 second to decrease the Zone number (Zone 4→Zone 3→Zone 2→Zone 1→Zone 4).

- **Side 1** and **Side 2** buttons are the default settings.

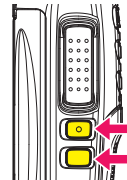

SELECT A CHANNEL

Rotate the **Selector** to select your desired channel.



MAKE A CALL

Press and hold the **PTT** switch, then speak into the microphone using your normal speaking voice.

- Hold the microphone approximately 3 to 4 cm (1.5 inches) from your mouth.

Release the **PTT** switch to receive.

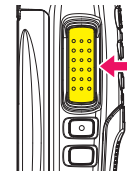

Note:

- ◆ When the battery pack voltage becomes too low, transmission will stop and an alert tone will sound.

RECEIVE VOICE

The LED lights green.

When the other party transmits it, you hear the voice of the other party.

POWER OFF

After use, turn off the power. To switch the transceiver power OFF, turn the **Power** switch/ **Volume** control fully counterclockwise, until a click sounds.



LED Indicator Status

Indicator Color	Meaning
Lights red	Transmitting
Lights green	Receiving a call.
Blinks red	Battery power is low.
Blinks green	Scanning

SELF-PROGRAMMING MODE

This mode allows you to program the certain transceiver's settings of zone and channel.

SELF-PROGRAMMING FLOW

Self-programming flow has two patterns depending on the model.

NX-P1200NV/ NX-P1300NU (NXDN/ Analog Transceiver)

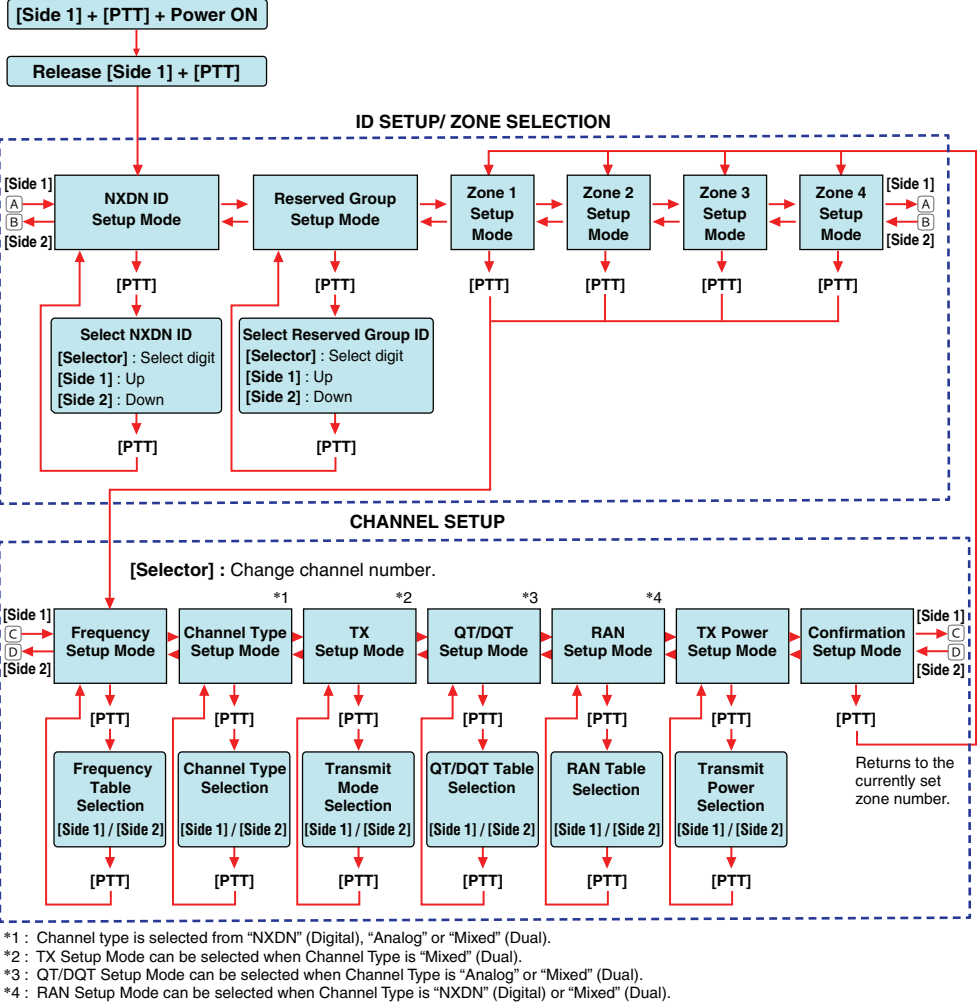

Power OFF and then ON

Return to normal operation

NX-P1200AV/ NX-P1202AV/ NX-P1300AU/ NX-P1302AU (Analog Transceiver)

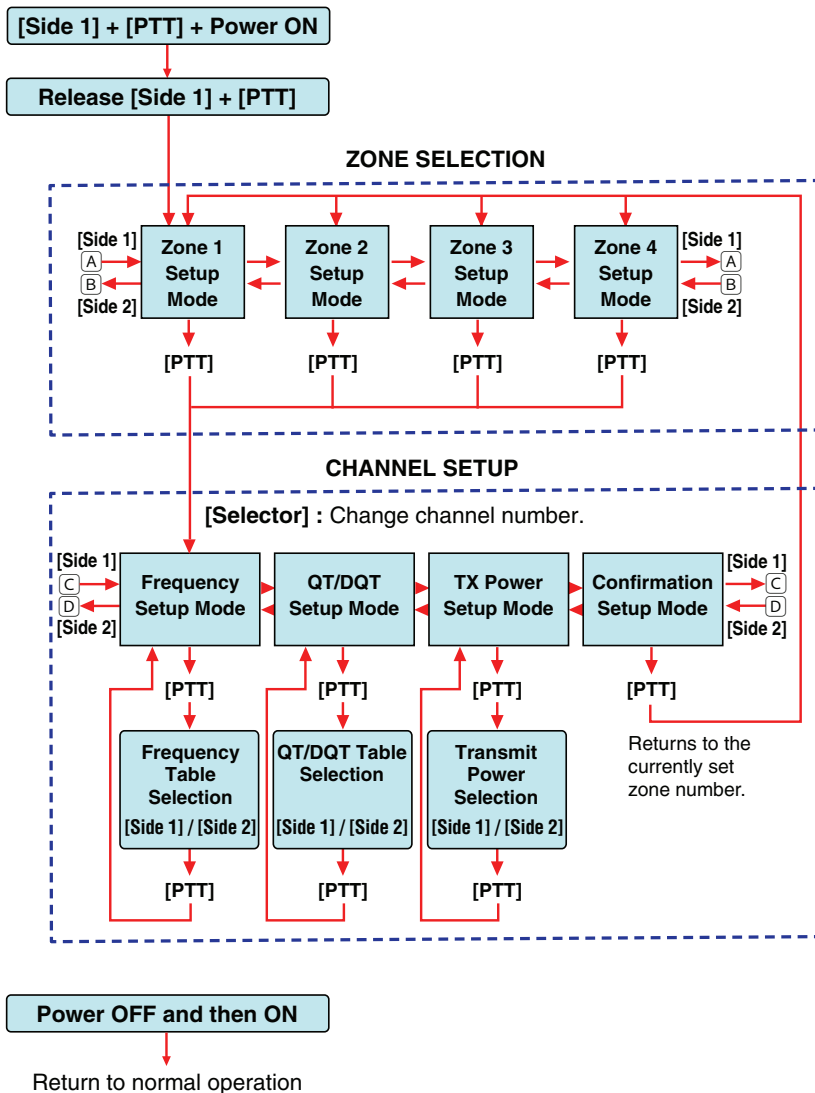

DEFAULT CHANNEL SETTINGS

This transceiver allows you to reprogram each of the channels with different frequencies and QT tone/DQT code (Analog)/ RAN (NXDN (Digital)) settings.

NX-P1200NV

Channel Number	Zone 1/ Zone 2 (Analog)				Zone 3/ Zone 4 (Digital)			
	Table No.	Frequency (MHz)	Table No.	QT (Hz)	Table No.	Frequency (MHz)	Table No.	RAN
1	1	151.6250	1	67.0	1	151.6250	1	1
2	1	151.6250	4	77.0	1	151.6250	2	2
3	1	151.6250	8	88.5	1	151.6250	3	3
4	1	151.6250	29	179.9	1	151.6250	4	4
5	1	151.6250	12	100.0	1	151.6250	5	5
6	2	151.9550	1	67.0	2	151.9550	1	1
7	2	151.9550	6	82.5	2	151.9550	2	2
8	2	151.9550	10	94.8	2	151.9550	3	3
9	2	151.9550	29	179.9	2	151.9550	4	4
10	2	151.9550	12	100.0	2	151.9550	5	5
11	20	154.4900	1	67.0	20	154.4900	1	1
12	21	154.5150	1	67.0	21	154.5150	1	1
13	10	151.5125	1	67.0	10	151.5125	1	1
14	12	151.6850	1	67.0	12	151.6850	1	1
15	5	151.7000	1	67.0	5	151.7000	1	1
16	6	151.7600	1	67.0	6	151.7600	1	1

Compatible KENWOOD Model

Zone Number	Model Name
Zone 1/ Zone 2	NX-P1200AV (Zone 1 ~ 4)/ NX-P1202AV (Zone 2 ~ 4)/ NX-240 (Analog Mode)/ TK-2402V
Zone 3/ Zone 4	NX-240 (Digital Mode)

NX-P1200AV (Analog Transceiver)

Channel Number	Zone 1 ~ Zone 4			
	Table No.	Frequency (MHz)	Table No.	QT (Hz)
1	1	151.6250	1	67.0
2	1	151.6250	4	77.0
3	1	151.6250	8	88.5
4	1	151.6250	29	179.9
5	1	151.6250	12	100.0
6	2	151.9550	1	67.0
7	2	151.9550	6	82.5
8	2	151.9550	10	94.8
9	2	151.9550	29	179.9
10	2	151.9550	12	100.0
11	20	154.4900	1	67.0
12	21	154.5150	1	67.0
13	10	151.5125	1	67.0
14	12	151.6850	1	67.0
15	5	151.7000	1	67.0
16	6	151.7600	1	67.0

Compatible KENWOOD Model

Zone Number	Model Name
Zone 1 ~ Zone 4	NX-P1200NV (Zone 1/ 2)/ NX-P1202AV (Zone 2 ~ 4)/ NX-240 (Analog Mode)/ TK-2402V

NX-P1202AV (Analog Transceiver)

Channel Number	Zone 1				Zone 2 ~ Zone 4			
	Table No.	Frequency (MHz)	Table No.	QT (Hz)	Table No.	Frequency (MHz)	Table No.	QT (Hz)
1	20	154.4900	1	67.0	1	151.6250	1	67.0
2	21	154.5150	1	67.0	1	151.6250	4	77.0
3	1	151.6250	1	67.0	1	151.6250	8	88.5
4	2	151.9550	1	67.0	1	151.6250	29	179.9
5	10	151.5125	1	67.0	1	151.6250	12	100.0
6	12	151.6850	1	67.0	2	151.9550	1	67.0
7	15	151.7750	1	67.0	2	151.9550	6	82.5
8	26	158.4000	1	67.0	2	151.9550	10	94.8
9	1	151.6250	4	77.0	2	151.9550	29	179.9
10	1	151.6250	8	88.5	2	151.9550	12	100.0
11	1	151.6250	29	179.9	20	154.4900	1	67.0
12	2	151.9550	6	82.5	21	154.5150	1	67.0
13	2	151.9550	10	94.8	10	151.5125	1	67.0
14	2	151.9550	29	179.9	12	151.6850	1	67.0
15	5	151.7000	1	67.0	5	151.7000	1	67.0
16	6	151.7600	1	67.0	6	151.7600	1	67.0

Compatible KENWOOD Model

Zone Number	Model Name
Zone 1	TK-2400
Zone 2 ~ Zone 4	NX-P1200NV (Zone 1/ 2) NX-P1200AV (Zone 1 ~ 4)/ NX-240 (Analog Mode)/ TK-2402V

NX-P1300NU (NXDN/ Analog Transceiver)

Channel Number	Zone 1/ Zone 2 (Analog)				Zone 3 (Digital)			
	Table No.	Frequency (MHz)	Table No.	QT (Hz)	Table No.	Frequency (MHz)	Table No.	RAN
1	1	464.5000	1	67.0	1	464.5000	1	1
2	1	464.5000	4	77.0	1	464.5000	2	2
3	1	464.5000	8	88.5	1	464.5000	3	3
4	1	464.5000	29	179.9	1	464.5000	4	4
5	1	464.5000	12	100.0	1	464.5000	5	5
6	2	464.5500	1	67.0	2	464.5500	1	1
7	2	464.5500	6	82.5	2	464.5500	2	2
8	2	464.5500	10	94.8	2	464.5500	3	3
9	2	464.5500	29	179.9	2	464.5500	4	4
10	2	464.5500	12	100.0	2	464.5500	5	5
11	22	461.3625	3	74.4	22	461.3625	1	1
12	30	464.4875	5	79.7	30	464.4875	1	1
13	32	464.5375	7	85.4	32	464.5375	1	1
14	34	466.0375	9	91.5	34	466.0375	1	1
15	36	466.0875	11	97.4	36	466.0875	1	1
16	38	466.1375	13	103.5	38	466.1375	1	1

Channel Number	Zone 4 (Digital)			
	Table No.	Frequency (MHz)	Table No.	RAN
1	2	464.5500	1	1
2	8	467.9250	1	1
3	9	461.0375	1	1
4	10	461.0625	1	1
5	11	461.0875	1	1
6	12	461.1125	1	1
7	13	461.1375	1	1
8	14	461.1625	1	1
9	1	464.5000	1	1
10	3	467.7625	1	1
11	4	467.8125	1	1
12	5	467.8500	1	1
13	6	467.8750	1	1
14	7	467.9000	1	1
15	15	461.1875	1	1
16	16	461.2125	1	1

Compatible KENWOOD Model

Zone Number	Model Name
Zone 1/ Zone 2	NX-P1300AU (Zone 1 ~ 4)/ NX-P1302AU (Zone 2 ~ 4)/ NX-340 (Analog Mode)/ TK-3402U
Zone 3	NX-340 (Digital Mode)
Zone 4	NX-P500 (Digital Mode)

NX-P1300AU (Analog Transceiver)

Channel Number	Zone 1 ~ Zone 4			
	Table No.	Frequency (MHz)	Table No.	QT (Hz)
1	1	464.5000	1	67.0
2	1	464.5000	4	77.0
3	1	464.5000	8	88.5
4	1	464.5000	29	179.9
5	1	464.5000	12	100.0
6	2	464.5500	1	67.0
7	2	464.5500	6	82.5
8	2	464.5500	10	94.8
9	2	464.5500	29	179.9
10	2	464.5500	12	100.0
11	22	461.3625	3	74.4
12	30	464.4875	5	79.7
13	32	464.5375	7	85.4
14	34	466.0375	9	91.5
15	36	466.0875	11	97.4
16	38	466.1375	13	103.5

Compatible KENWOOD Model

Zone Number	Model Name
Zone 1 ~ Zone 4	NX-P1300NU (Zone 1/ 2)/ NX-P1302AU (Zone 2 ~ 4)/ NX-340 (Analog Mode)/ TK-3402U

NX-P1302AU (Analog Transceiver)

Channel Number	Zone 1				Zone 2 ~ Zone 4			
	Table No.	Frequency (MHz)	Table No.	QT (Hz)	Table No.	Frequency (MHz)	Table No.	QT (Hz)
1	2	464.5500	1	67.0	1	464.5000	1	67.0
2	8	467.9250	1	67.0	1	464.5000	4	77.0
3	9	461.0375	1	67.0	1	464.5000	8	88.5
4	10	461.0625	1	67.0	1	464.5000	29	179.9
5	11	461.0875	1	67.0	1	464.5000	12	100.0
6	12	461.1125	1	67.0	2	464.5500	1	67.0
7	13	461.1375	1	67.0	2	464.5500	6	82.5
8	14	461.1625	1	67.0	2	464.5500	10	94.8
9	1	464.5000	1	67.0	2	464.5500	29	179.9
10	3	467.7625	1	67.0	2	464.5500	12	100.0
11	4	467.8125	1	67.0	22	461.3625	3	74.4
12	5	467.8500	1	67.0	30	464.4875	5	79.7
13	6	467.8750	1	67.0	32	464.5375	7	85.4
14	7	467.9000	1	67.0	34	466.0375	9	91.5
15	15	461.1875	1	67.0	36	466.0875	11	97.4
16	16	461.2125	1	67.0	38	466.1375	13	103.5

Compatible KENWOOD Model

Zone Number	Model Name
Zone 1	TK-3400/ NX-P500 (Analog Mode)
Zone 2 ~ Zone 4	NX-P1300NU (Zone 1/ 2)/ NX-P1300AU (Zone 1 ~ 4)/ NX-340 (Analog Mode)/ TK-3402U

ID SETUP

NXDN ID Setup (Digital)

NXDN ID Setup allows you to configure an identification code. NXDN ID (Own unit ID) can be used to identify the transceiver in an NXDN System.

You can set the NXDN ID from 00001 to 65519. The default NXDN ID is “00001”.

To set the NXDN ID

- 1 With the transceiver power OFF, press and hold the **Side 1** button and **PTT** switch while turning the transceiver power ON.
 - Continue to hold the **Side 1** button and **PTT** switch until the LED lights yellow and the transceiver announces “Self”.
- 2 Release the **Side 1** button and **PTT** switch to enter the ID SETUP/ ZONE SELECTION.
 - The transceiver announces “NXDN ID”.
- 3 Press the **PTT** switch to enter the NXDN ID Setup Mode.
- 4 Turn the **Selector** to set the pointer to the desired digit (1 ~ 5).
 - A voice announcement will inform selected number.
 - If you select more than 5 digit, error beep will sound.
- 5 Press the **Side 1** to increase the number, press the **Side 2** to decrease the number (0 ~ 9).
 - A voice announcement will inform selected number.
 - Repeat steps 4 to 5 to select the number of each digit.
 - For example, when you set the NXDN ID as “12345”, you should operate the **Selector**, **Side 1** and **Side 2** buttons according to the following table.

Selector position	5	4	3	2	1
Selected number	1	2	3	4	5

- 6 Press the **PTT** switch to save the settings and return to the ID SETUP/ ZONE SELECTION.
 - A voice announcement will inform you of the currently selected NXDN ID number. For example, when “12345” is selected, voice announcement: “ID, One, Two, Three, Four, Five”.
 - Turn the transceiver power OFF and then ON return to normal operation with new settings.

Note:

- ◆ If no action is performed for 20 seconds, the transceiver will automatically return to normal operation without changing any settings.
-

Reserved Group Setup (Digital)

Reserved Group Setup allows you to configure the Reserved Group ID.

Reserved Group ID is the ID that is the destination of Group Call communication in the channel where Selcall on PTT > Call Type (NXDN) is set to “Reserved Group”.

You can set the Reserved Group ID from “00001” to “65519”. The default ID is “00100”.

- Only on the channels in Zone 4 of NX-P1300NU, Reserved Group function (making a Group Call with the Reserved Group ID) can be used by default settings.
- If you use Reserved Group function on NX-P1200NV or the other zones of NX-P1300NU, the settings by your dealer are required.
- Reserved Group ID: 00100 is compatible with NX-P500.
- If other parties use the same frequency, changing the Reserved Group ID and making a Group Call with a Group ID other than “00100” can prevent unnecessary reception.

A group call is initiated to the transceiver of the same Reserved Group ID if the **PTT** switch is pressed.

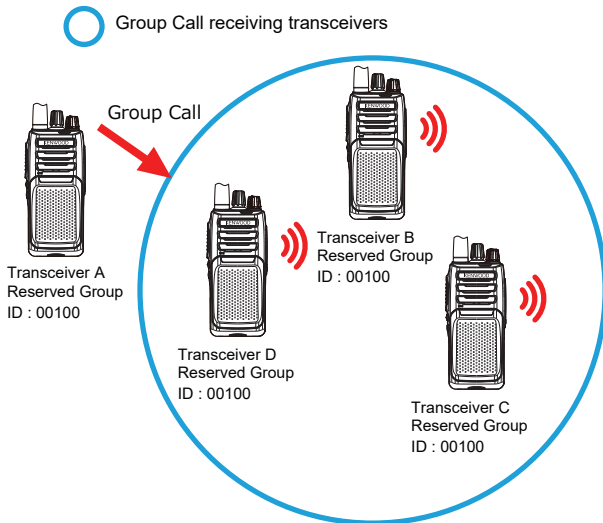

To set the Reserved Group ID

- 1 With the transceiver power OFF, press and hold the **Side 1** button and **PTT** switch while turning the transceiver power ON.
 - Continue to hold the **Side 1** button and **PTT** switch until the LED lights yellow and the transceiver announces “Self”.
- 2 Release the **Side 1** button and **PTT** switch to enter the ID SETUP/ ZONE SELECTION.

- 3 Press the **Side 1** or **Side 2** button to select the Reserved Group Setup Mode.
 - The transceiver announces “Group ID”.
- 4 Press the **PTT** switch to enter the Reserved Group Setup Mode.
- 5 Turn the **Selector** to set the pointer to the desired digit (1 ~ 5).
 - A voice announcement will inform selected number.
 - If you select more than 5 digit, error beep will sound.
- 6 Press the **Side 1** to increase the number, press the **Side 2** to decrease the number (0 ~ 9).
 - A voice announcement will inform selected number.
 - Repeat steps 5 to 6 to select the number of each digit.
 - For example, when you set the Reserved Group ID as “00250”, you should operate the **Selector**, **Side 1** and **Side 2** buttons according to the following table.

Selector position	5	4	3	2	1
Selected number	0	0	2	5	0

- 7 Press the **PTT** switch to save the settings and return to the ID SETUP/ ZONE SELECTION.
 - A voice announcement will inform you of the currently selected Reserved Group ID number. For example, when “00250” is selected, voice announcement: “ID, Zero, Zero, Two, Five, Zero”.
 - Turn the transceiver power OFF and then ON return to normal operation with new settings.

Note:

- ◆ If no action is performed for 20 seconds, the transceiver will automatically return to normal operation without changing any settings.
-

ZONE SELECTION

- 1 With the transceiver power OFF, press and hold the **Side 1** button and **PTT** switch while turning the transceiver power ON.
 - Continue to hold the **Side 1** button and **PTT** switch until the LED lights yellow and the transceiver announces “Self”.
- 2 Release the **Side 1** button and **PTT** switch to enter the ID SETUP/ ZONE SELECTION.
- 3 Press the **Side 1** or **Side 2** button to select a zone number.
 - A voice announcement will inform you of the currently selected zone number.
- 4 Press the **PTT** switch to decide current selected zone and enter the CHANNEL SETUP {p. 23}.
 - A voice announcement will inform you of the currently selected zone number and channel number “Zone X” (X = 1 to 4 for zone number), “Channel Y” (Y = 1 to 16 for channel number).

Note:

- ◆ If no action is performed for 20 seconds, the transceiver will automatically return to normal operation without changing any settings.
-

CHANNEL SETUP

Frequency Setup

To set the Frequency

- 1 During CHANNEL SETUP, rotate the **Selector** to select a channel number.
 - The transceiver announces the zone number and channel number.
- 2 Press the **Side 1** or **Side 2** button to select the Frequency Setup Mode.
 - The transceiver announces “Channel”.
- 3 Press the **PTT** switch to enter the Frequency Table Selection.
 - The transceiver will announce the current frequency table number.
- 4 Press the **Side 1** or **Side 2** button to increment/ decrement the frequency table number, to select the new channel frequency.
 - A voice announcement: “Table X” (X = 1 to 27 for VHF, X = 1 to 99 for UHF).
 - A voice announcement will inform you of the currently selected frequency table number.
 - Table numbers and their corresponding operating frequencies are provided in the table {VHF: p. 24} {UHF: p. 25}.
 - Press and hold the **Side 1** or **Side 2** button to increment/ decrement the frequency table number by 5 at a time.
- 5 Press the **PTT** switch to temporary save the selected frequency table number.
 - Beep B (2 beeps) will sound.
 - Repeat steps 1 to 5 to set up another channel.
- 6 Press the **Side 1** or **Side 2** button to select the Confirmation Setup Mode.
 - The transceiver announces “Confirm”.
- 7 Press the **PTT** switch to save the settings and return to the ID SETUP/ ZONE SELECTION.
 - Beep B (2 beeps) will sound.
 - Turn the transceiver power OFF and then ON return to normal operation with new settings.

Note:

- ◆ If no action is performed for 20 seconds, the transceiver will automatically return to normal operation without changing any settings.
-

VHF Frequency Table

Table Number	Frequency (MHz)
1	151.625000
2	151.955000
3	152.885000
4	152.915000
5	151.700000
6	151.760000
7	152.945000
8	151.835000
9	151.805000
10	151.512500
11	151.655000
12	151.685000
13	151.715000
14	151.745000
15	151.775000
16	151.865000
17	151.895000
18	151.925000
19	152.900000
20	154.490000
21	154.515000
22	154.527500
23	154.540000
24	153.005000
25	154.547500
26	158.400000
27	158.407500

UHF Frequency Table

Table Number	Frequency (MHz)	Table Number	Frequency (MHz)	Table Number	Frequency (MHz)
1	464.500000	34	466.037500	67	451.287500
2	464.550000	35	466.062500	68	451.337500
3	467.762500	36	466.087500	69	451.437500
4	467.812500	37	466.112500	70	451.537500
5	467.850000	38	466.137500	71	451.637500
6	467.875000	39	466.162500	72	452.312500
7	467.900000	40	466.187500	73	452.537500
8	467.925000	41	466.212500	74	452.412500
9	461.037500	42	466.237500	75	452.512500
10	461.062500	43	466.262500	76	452.762500
11	461.087500	44	466.287500	77	452.862500
12	461.112500	45	466.312500	78	456.187500
13	461.137500	46	466.337500	79	456.237500
14	461.162500	47	466.362500	80	456.287500
15	461.187500	48	467.787500	81	468.212500
16	461.212500	49	467.837500	82	468.262500
17	461.237500	50	467.862500	83	468.312500
18	461.262500	51	467.887500	84	468.362500
19	461.287500	52	467.912500	85	468.412500
20	461.312500	53	469.487500	86	468.462500
21	461.337500	54	469.512500	87	468.512500
22	461.362500	55	469.537500	88	468.562500
23	462.762500	56	469.562500	89	468.612500
24	462.787500	57	462.187500	90	468.662500
25	462.812500	58	462.462500	91	456.337500
26	462.837500	59	462.487500	92	456.437500
27	462.862500	60	462.512500	93	456.537500
28	462.887500	61	467.187500	94	456.637500
29	462.912500	62	467.462500	95	457.312500
30	464.487500	63	467.487500	96	457.412500
31	464.512500	64	467.512500	97	457.512500
32	464.537500	65	451.187500	98	457.762500
33	464.562500	66	451.237500	99	457.862500

Channel Type Setup

Set the Channel Type of the selected Zone-Channel to “Analog”, “NXDN” (Digital), or “Mixed” (Dual). The following is the transceiver behavior for transmission and reception on a channel with “Mixed” (Dual) configured in Channel Type:

Transmission: The transceiver transmits in the mode (Analog or NXDN) configured in the TX Setup Mode {p. 27}.

Reception: Mixed mode can be used to wait for a call in both Analog (QT tone and DQT code) and Digital (RAN) modes.

To set the Channel Type

- 1 During CHANNEL SETUP, rotate the **Selector** to select a channel number.
 - The transceiver announces the zone number and channel number.
- 2 Press the **Side 1** or **Side 2** button to select the Channel Type Setup Mode.
 - The transceiver announces “Channel Type”.
 - If the Frequency of the currently selected channel is set to “Off”, the Channel Type Setup Mode cannot be selected.
- 3 Press the **PTT** switch to enter the Channel Type Selection.
- 4 Press the **Side 1** or **Side 2** button to select the Channel Type.

Channel Type	Voice Announcement	Description
Analog	Channel Type Analog	Operate in Analog mode.
NXDN	Channel Type Digital	Operate in Digital mode.
Mixed	Channel Type Dual	Operate in Analog / Digital Mixed mode.

- 5 Press the **PTT** switch to temporary save the selected Channel Type.
 - Beep B (2 beeps) will sound.
 - Repeat steps 1 to 5 to set up another channel.
- 6 Press the **Side 1** or **Side 2** button to select the Confirmation Setup Mode.
 - The transceiver announces “Confirm”.
- 7 Press the **PTT** switch to save the settings and return to the ID SETUP/ ZONE SELECTION.
 - Beep B (2 beeps) will sound.
 - Turn the transceiver power OFF and then ON return to normal operation with new settings.

Note:

- ◆ If no action is performed for 20 seconds, the transceiver will automatically return to normal operation without changing any settings.
-

TX Setup

When Channel Type is “Mixed” (Dual), set to “Analog” or “NXDN” (Digital) for Transmit Mode.

To set the Transmit Mode

- 1 During CHANNEL SETUP, rotate the **Selector** to select a channel number.
 - The transceiver announces the zone number and channel number.
- 2 Press the **Side 1** or **Side 2** button to select the TX Setup Mode.
 - The transceiver announces “TX Mode”.
 - If the Frequency of the currently selected channel is set to “Off”, the TX Setup Mode cannot be selected.
 - If the Channel Type is set to “Analog” or “NXDN” (Digital), the TX Setup Mode cannot be selected.
- 3 Press the **PTT** switch to enter the Transmit Mode Selection.
- 4 Press the **Side 1** or **Side 2** button to select the Transmit Mode.

Transmit Mode	Voice Announcement	Description
Analog	TX Mode Analog	Transmitting in Analog.
NXDN	TX Mode Digital	Transmitting in Digital.

- 5 Press the **PTT** switch to temporary save the selected Transmit Mode.
 - Beep B (2 beeps) will sound.
 - Repeat steps 1 to 5 to set up another channel.
- 6 Press the **Side 1** or **Side 2** button to select the Confirmation Setup Mode.
 - The transceiver announces “Confirm”.
- 7 Press the **PTT** switch to save the settings and return to the ID SETUP/ ZONE SELECTION.
 - Beep B (2 beeps) will sound.
 - Turn the transceiver power OFF and then ON return to normal operation with new settings.

Note:

- ◆ If no action is performed for 20 seconds, the transceiver will automatically return to normal operation without changing any settings.
-

Operation

- If Transmit Mode is set to “Analog”, the transceiver will respond to a call in Analog format.
- If Transmit Mode is set to “NXDN” (Digital), the transceiver will respond to a call in NXDN format.
- In a mixed channel, if the transceiver receives matched Signaling (QT/DQT/RAN), the transceiver will be able to transmit in the same mode as that of the received signal before the Signaling Reset Timer (10 seconds) elapses, regardless of the Transmit Mode settings.
 - This operation of transmitting in the same mode as that of the received signal is called Talkback.
 - The operation when transmission is done on a mixed channel while receiving a signal is as follows.

Transmit Mode	Received Signal	TX Operation when Signaling is mismatched		TX Operation when Signaling is matched	
		Analog Transmission	NXDN Transmission	Analog Transmission	NXDN Transmission
Analog	Analog	O	X	O	X
Analog	Digital	O	X	X	O
NXDN	Analog	X	O	O	X
NXDN	Digital	X	O	X	O

O: Can transmit

X: Cannot transmit

QT/DQT Setup (Analog)

Quiet Talk (QT) and Digital Quiet Talk (DQT) are functions that reject undesired signals on your channel. You will hear a call only when you receive a signal that contains a matching QT tone or DQT code. If a call containing a different tone or code is received, squelch will not open and you will not hear the call. Likewise, when transmitting using QT tone or DQT code, the receiving station must have a matching tone or code to hear your call.

Be aware that other parties can still hear your calls if they set up their transceiver with the same tone or code.

To set the QT/DQT

- 1 During CHANNEL SETUP, rotate the **Selector** to select a channel number.
 - The transceiver announces the zone number and channel number.
- 2 Press the **Side 1** or **Side 2** button to select the QT/DQT Setup Mode.
 - The transceiver announces “QT/DQT”.
 - If the Frequency of the currently selected channel is set to “Off”, the QT/DQT Setup Mode cannot be selected.
 - If the Channel Type is set to “NXDN” (Digital), the QT/DQT Setup Mode cannot be selected.
- 3 Press the **PTT** switch to enter the QT/DQT Table Selection.
 - The transceiver announces the current QT/DQT table number.
- 4 Press the **Side 1** or **Side 2** button to increment/ decrement the QT/DQT table number. (Table 0 (“QT DQT 0”) ↔ QT Table 1 (“QT 1”) ↔ QT Table 2 ↔ ... ↔ QT Table 45 ↔ DQT Table 1 (“DQT 1”) ↔ DQT Table 2 ↔ ... ↔ DQT Table 174 ↔ Table 0 (“QT DQT 0”)).
 - A voice announcement: “QT DQT 0”/ “QT X” (X = 1 to 45)/ “DQT X” (X = 1 to 174).
 - A voice announcement will inform you of the currently selected QT/DQT table number.
 - QT/DQT table numbers and their corresponding tones/ codes are provided in the table {QT: p. 30} {DQT: p. 31}.
 - When table number set to “0” (“QT DQT 0”), QT/DQT signaling is off.
 - Press and hold the **Side 1** or **Side 2** button to increment/ decrement the QT/DQT table number by 5 at a time.
- 5 Press the **PTT** switch to temporary save the selected QT/DQT.
 - Beep B (2 beeps) will sound.
 - Repeat steps 1 to 5 to set up another channel.
- 6 Press the **Side 1** or **Side 2** button to select the Confirmation Setup Mode.
 - The transceiver announces “Confirm”.

7 Press the **PTT** switch to save the settings and return to the **ID SETUP/ ZONE SELECTION**.

- Beep B (2 beeps) will sound.
- Turn the transceiver power **OFF** and then **ON** return to normal operation with new settings.

Note:

- ◆ If no action is performed for 20 seconds, the transceiver will automatically return to normal operation without changing any settings.

Table Number	QT/DQT
0	Off

QT Table

Table Number	QT Frequency (Hz)	Table Number	QT Frequency (Hz)	Table Number	QT Frequency (Hz)
1	67.0	21	136.5	41	67.0
2	71.9	22	141.3	42	67.0
3	74.4	23	146.2	43	67.0
4	77.0	24	151.4	44	67.0
5	79.7	25	156.7	45	67.0
6	82.5	26	162.2		
7	85.4	27	167.9		
8	88.5	28	173.8		
9	91.5	29	179.9		
10	94.8	30	186.2		
11	97.4	31	192.8		
12	100.0	32	203.5		
13	103.5	33	210.7		
14	107.2	34	218.1		
15	110.9	35	225.7		
16	114.8	36	233.6		
17	118.8	37	241.8		
18	123.0	38	250.3		
19	127.3	39	69.3		
20	131.8	40	67.0		

Note:

- ◆ Table Number 40 to 45 can be changed by your dealer.

DQT Table

Table Number	DQT Code	Table Number	DQT Code	Table Number	DQT Code	Table Number	DQT Code	Table Number	DQT Code
1	D023N	36	D251N	71	D631N	106	D143I	141	D445I
2	D025N	37	D261N	72	D632N	107	D152I	142	D464I
3	D026N	38	D263N	73	D654N	108	D155I	143	D465I
4	D031N	39	D265N	74	D662N	109	D156I	144	D466I
5	D032N	40	D271N	75	D664N	110	D162I	145	D503I
6	D043N	41	D306N	76	D703N	111	D165I	146	D506I
7	D047N	42	D311N	77	D712N	112	D172I	147	D516I
8	D051N	43	D315N	78	D723N	113	D174I	148	D532I
9	D054N	44	D331N	79	D731N	114	D205I	149	D546I
10	D065N	45	D343N	80	D732N	115	D223I	150	D565I
11	D071N	46	D346N	81	D734N	116	D226I	151	D606I
12	D072N	47	D351N	82	D743N	117	D243I	152	D612I
13	D073N	48	D364N	83	D754N	118	D244I	153	D624I
14	D074N	49	D365N	84	D645N	119	D245I	154	D627I
15	D114N	50	D371N	85	D023I	120	D251I	155	D631I
16	D115N	51	D411N	86	D025I	121	D261I	156	D632I
17	D116N	52	D412N	87	D026I	122	D263I	157	D654I
18	D125N	53	D413N	88	D031I	123	D265I	158	D662I
19	D131N	54	D423N	89	D032I	124	D271I	159	D664I
20	D132N	55	D431N	90	D043I	125	D306I	160	D703I
21	D134N	56	D432N	91	D047I	126	D311I	161	D712I
22	D143N	57	D445N	92	D051I	127	D315I	162	D723I
23	D152N	58	D464N	93	D054I	128	D331I	163	D731I
24	D155N	59	D465N	94	D065I	129	D343I	164	D732I
25	D156N	60	D466N	95	D071I	130	D346I	165	D734I
26	D162N	61	D503N	96	D072I	131	D351I	166	D743I
27	D165N	62	D506N	97	D073I	132	D364I	167	D754I
28	D172N	63	D516N	98	D074I	133	D365I	168	D645I
29	D174N	64	D532N	99	D114I	134	D371I	169	D023N
30	D205N	65	D546N	100	D115I	135	D411I	170	D023N
31	D223N	66	D565N	101	D116I	136	D412I	171	D023N
32	D226N	67	D606N	102	D125I	137	D413I	172	D023N
33	D243N	68	D612N	103	D131I	138	D423I	173	D023N
34	D244N	69	D624N	104	D132I	139	D431I	174	D023N
35	D245N	70	D627N	105	D134I	140	D432I		

Note:

- ◆ Table Number 169 to 174 can be changed by your dealer.

RAN Setup (Digital)

RAN (Radio Access Number) is a signaling system designed for NXDN System. When a channel is setup with a RAN, squelch will only open when a call containing a matching RAN is received. If a call containing a different RAN is made on the same channel are using, you will not hear the call. This allows you to ignore (not hear) calls from other parties who are using the same channel.

To set the RAN

- 1 During CHANNEL SETUP, rotate the **Selector** to select a channel number.
 - The transceiver announces the zone number and channel number.
- 2 Press the **Side 1** or **Side 2** button to select the RAN Setup Mode.
 - The transceiver announces “RAN”.
- 3 Press the **PTT** switch to enter the RAN Table Selection.
 - The transceiver will announce the current RAN table number.
- 4 Press the **Side 1** or **Side 2** to increment/ decrement the RAN table number.
 - A voice announcement: “RAN X” (X = 0 to 63).
 - A voice announcement will inform you of the currently selected RAN table number.
 - When RAN table number set to “0” (“RAN 0”), RAN signaling is off.
 - Press and hold the **Side 1** or **Side 2** button to increment/ decrement the RAN table number by 5 at a time.
- 5 Press the **PTT** switch to temporary save the selected RAN table number.
 - Beep B (2 beeps) will sound.
 - Repeat steps 1 to 5 to set up another channel.
- 6 Press the **Side 1** or **Side 2** button to select the Confirmation Setup Mode.
 - The transceiver announces “Confirm”.
- 7 Press the **PTT** switch to save the settings and return to the ID SETUP/ ZONE SELECTION
 - Beep B (2 beeps) will sound.
 - Turn the transceiver power OFF and then ON return to normal operation with new settings.

Note:

- ◆ If no action is performed for 20 seconds, the transceiver will automatically return to normal operation without changing any settings.
-

TX Power Setup

To set the Transmit Power

- 1 During CHANNEL SETUP, rotate the **Selector** to select a channel number.
 - The transceiver announces the zone number and channel number.
- 2 Press the **Side 1** or **Side 2** button to select the TX Power Setup Mode.
 - The transceiver announces “TX Power”.
 - If the Frequency of the currently selected channel is set to “Off”, the TX Power Setup Mode cannot be selected.
- 3 Press the **PTT** switch to enter the Transmit Power Selection.
- 4 Press the **Side 1** or **Side 2** button to select the Transmit Power.

NX-P1200NV/ NX-P1200AV/ NX-P1300NU/ NX-P1300AU

Transmit Power	Voice Announcement	Description
High	TX Power High	5 W
Medium	TX Power Medium	4 W
Low	TX Power Low	1 W

NX-P1202AV/ NX-P1302AU

Transmit Power	Voice Announcement	Description
High	TX Power High	2 W
Low	TX Power Low	1 W

- 5 Press the **PTT** switch to temporary save the selected Transmit Power.
 - Beep B (2 beeps) will sound.
 - Repeat steps 1 to 5 to set up another channel.
- 6 Press the **Side 1** or **Side 2** button to select the Confirmation Setup Mode.
 - The transceiver announces “Confirm”.
- 7 Press the **PTT** switch to save the settings and return to the ID SETUP/ ZONE SELECTION
 - Beep B (2 beeps) will sound.
 - Turn the transceiver power OFF and then ON return to normal operation with new settings.

Note:

- ◆ If no action is performed for 20 seconds, the transceiver will automatically return to normal operation without changing any settings.
-

CHANNEL CONFIRMATION MODE

To confirm your channel settings:

- 1 With the transceiver power OFF, press and hold the **PTT** switch while turning the transceiver power ON.
 - Continue to hold the **PTT** switch until the LED lights yellow and the transceiver announces “Confirm”.
- 2 Release the **PTT** switch.
 - The transceiver announces the Zone number of the selected channel.
- 3 Rotate the **Selector** to desired channel.

The transceiver announces the information of the current channel.

NX-P1200NV/ NX-P1300NU

Channel Type: Analog

Zone number, Channel number, Channel type, Frequency table number, QT/DQT table number, Transmit power, Scrambler status, and VOX status.

(Example: “Zone 1, Channel 1, Analog, Table 10, DQT 15, High Power, Scrambler (when active), VOX (when active)”)

Channel Type: NXDN

Zone number, Channel number, Channel type, Frequency table number, RAN table number, Transmit power, Encryption status, and VOX status.

(Example: “Zone 1, Channel 1, Digital, Table 10, RAN 55, High Power, Encryption (when active), VOX (when active)”)

Channel Type: Mixed

Zone number, Channel number, Channel type, Transmit mode, Frequency table number, QT/DQT table number, RAN table number, Transmit power, Scrambler status, Encryption status, and VOX status.

(Example: “Zone 1, Channel 1, Dual, Analog, Table 10, DQT 15, RAN 55, High Power, Scrambler (when active), Encryption (when active), VOX (when active)”)

NX-P1200AV/ NX-P1300AU/ NX-P1202AV/ NX-P1302AU

Zone number, Channel number, Frequency table number, QT/DQT table number, Transmit power, Scrambler status, and VOX status.

- Press the **PTT** switch to repeat the voice announcement of the channel information of the current channel.
- Press the **Side 1** or **Side 2** button to increment or decrement the zone number with voice announcement of zone number.
- If the QT/DQT or RAN of the currently selected channel is not set, the transceiver will not announce the QT/DQT or RAN table number.

Note:

- ◆ If no action is performed for 20 seconds, the transceiver will automatically return to normal operation without changing any settings.
-

BUTTON FUNCTION PROGRAMMING MODE

This transceiver allows you to reprogram the **Side 1** and **Side 2** buttons with any of the functions listed in the table below. Explanations on the use of each function are provided under “PROGRAMMABLE FUNCTIONS” {p. 37}.

FUNCTIONS LIST

Table Number	Press	Press and hold	Hold Delay Time (sec)	Operation during Super Lock
0	None		–	–
1	–	Button Lock	1	X
2	Calling Alert	–	–	O
3	External Speaker	–	–	X
4	Home Channel	Home Channel Select	3	X
5	Individual Reply	–	–	X
6	Low Transmit Power	–	–	X
7	Monitor	–	–	O
8	Monitor Momentary	–	–	O
9	Scan	Scan Temporary Delete	3	X
10	Scrambler/ Encryption	–	–	X
11	Speaker Attenuation	–	–	X
12	Squelch Off	–	–	O
13	Squelch Off Momentary	–	–	O
14	–	Super Lock	4	–
15	–	Zone Down	1	X
16	–	Zone Up	1	X
17	–	Channel Down	1	X
18	–	Channel Up	1	X

O: Can operate
X: Cannot operate

Note:

- ◆ No. 15 [**Zone Down**] and No. 16 [**Zone Up**] cannot be selected when [**Zone Select**] function {p. 43} is set to the **Selector** by your dealer.
- ◆ No. 17 [**Channel Down**] and No. 18 [**Channel Up**] cannot be selected when [**Channel Select**] function is set to the **Selector** (including the default settings).
- ◆ The “Press and hold” function is assigned automatically.

To set the functions of the Side 1 and Side 2 buttons

- 1 With the transceiver power OFF, press and hold the **Side 1** and **Side 2** buttons while turning the transceiver power ON.
 - Continue to hold the **Side 1** and **Side 2** buttons until the LED lights yellow and the transceiver announces “Setup”.
- 2 Release the button.
- 3 Press and hold the button to be reprogrammed (either the **Side 1** or **Side 2** button).
 - The transceiver will announce “Table 0”.
 - The selection table number starts from “Table 0”, not the current table number.
- 4 Release the button.
- 5 Press the **Side 1** or **Side 2** button to increment/ decrement the table number, to select the new button function.
 - Table numbers and their corresponding functions are provided in the table {p. 35}.
 - A voice announcement will inform you of the currently selected table number.
- 6 Press the **PTT** switch to save the settings.
 - Beep B (2 beeps) will sound and the transceiver will announce the new table number.
- 7 Turn the transceiver power OFF and then ON again to activate the new settings.

Note:

- ◆ If no action is performed for 20 seconds, the transceiver will automatically return to normal operation without changing any settings.
-

PROGRAMMABLE FUNCTIONS

Button Lock

Press and hold this button for 1 second to lock the transceiver buttons.

- Beep A (1 beep) sounds.

Press and hold this button for 1 second again to unlock the transceiver buttons.

- Beep B (2 beeps) sounds.

The following buttons/ functions can still be used when Button Lock is active:

- Button Lock
- Monitor
- Monitor Momentary
- Squelch Off
- Squelch Off Momentary

Note:

- ◆ The status of this function (enabled or disabled) is retained even if the transceiver is turned OFF.
-

Calling Alert

Press this button to send a calling alert to the other party. Calling alert tones help identify yourself to party members and inform them that you are calling.

- This function can be used when the channel type is “Analog” or “Mixed” (Dual).

External Speaker

If external speaker connected to the transceiver, select the output of the speaker to the external speaker or internal speaker.

Press this button to switch the external speaker or internal speaker.

Note:

- ◆ The status of this function (enabled or disabled) is retained even if the transceiver is turned OFF.
-

Home Channel

Allows you to jump to home channel. You can set your own Home Channel by selecting your desired channel using Home Channel Select.

- 1 Press this button to jump to Home Channel.
 - Beep A (1 beep) sounds.
 - 2 Press this button again to return to the formerly selected channel.
 - Beep B (2 beeps) sounds.
-

Note:

- ◆ In scan mode, this button can only work during scan paused state.
-

Home Channel Select

Allows you to set the currently selected channel to Home Channel.

- 1 Select the channel to be set as Home Channel.
- 2 Press and hold this button for 3 seconds to set the currently selected channel as the Home Channel.
 - Beep C (3 beeps) sounds.

Individual Reply

Allows you to make an Individual Call to the caller when receiving a Group Call.

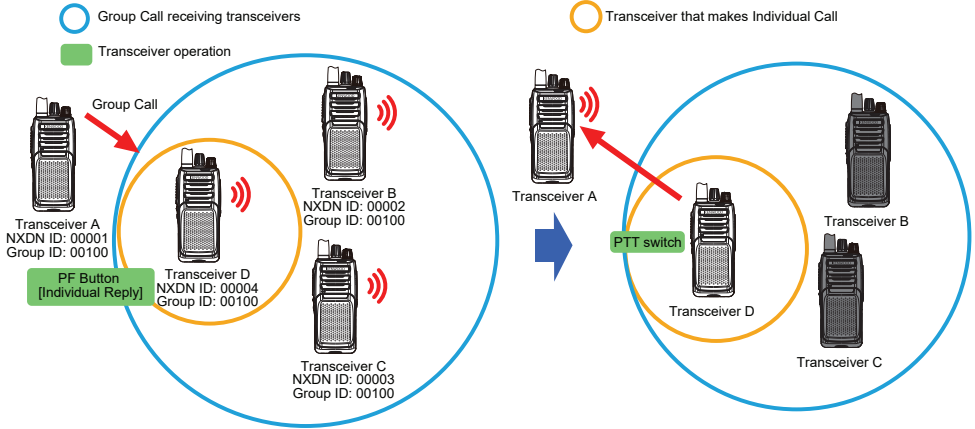

- 1 Press this button to enter the Individual Call mode while outputting the received voice or within 10 seconds after receiving the Group Call.
 - LED blinks light blue.
- 2 Press the **PTT** switch while the LED blinks light blue, you make the Individual Call to the caller.
 - If a new Group Call is received while the LED blinks light blue, Individual Call mode will be cancelled.

Note:

- ◆ Set a different NXDN ID for each transceiver.
 - ◆ Group Call can be sent with the following settings.
 - ① Select Reserved Group for Selcall on PTT > Call Type (NXDN) and send with the Reserved Group ID.
 - Only on the channels in Zone 4 of NX-P1300NU, Reserved Group function (making a Group Call with the Reserved Group ID) can be used by default settings.
 - For details, refer to “Reserved Group Setup (Digital)” {p. 20}.
 - ② Select Group Call for Selcall on PTT > Call Type (NXDN) and send with the Group ID of the Group ID List No.
 - To use this method, the settings by your dealer are required.
 - ◆ Set the Group ID to the same number on both Transmission and Reception sides.
 - ◆ To use the Individual Reply function in Analog mode, the settings by your dealer are required.
-

Low Transmit Power

Turns Low Transmit Power On or Off. When using a channel programmed with medium or high power, this allows you to change the output power to low.

Press this button to change the output power to Low.

- Beep A (1 beep) sounds.

Press this button again to change the transmit power to the original settings.

- Beep B (2 beeps) sounds.
-

Note:

- ◆ The status of this function (enabled or disabled) is retained even if the transceiver is turned OFF.
-

Monitor

On Digital mode, press this button to deactivate RAN signaling. Press the button again to return to normal operation. Squelch will open with any NXDN signals received regardless of the RAN settings.

On Analog mode, press this button to deactivate QT or DQT signaling. Press this button again to return to normal operation.

Monitor Momentary

On Digital mode, press and hold this button to deactivate RAN signaling. Release the button to return to normal operation. Squelch will open with any NXDN signals received regardless of the RAN settings.

On Analog mode, press and hold this button to deactivate QT or DQT signaling. Release this button to return to normal operation.

Scan

Press this button to start scanning the channels in the current zone.

In scan mode, press this button to stop scanning.

Note:

- ◆ The status of this function (enabled or disabled) is retained even if the transceiver is turned OFF.
-

Scan Temporary Delete

Temporarily deletes a channel added to the scanning sequence from the sequence. If a channel for which Scan Add is enabled is selected and if this button is pressed while scan pauses, the channel will be deleted from the scanning sequence.

- Beep B (2 beeps) sounds.
- Status of channel deleted from the scanning sequence by this function cannot be retained in the transceiver. Reactivating the scan by pressing the button programmed as **[Scan]** returns the transceiver to the original state.

Scrambler/ Encryption

Enables or disables Scrambler (Analog) or Encryption (Digital) function.

- Voice Scrambler is the function to scramble the audio signal so that the contents of communications can be prevented from being intercepted.
- Encryption is the function that enhances secrecy in communications on the NXDN system by encrypting voice data.

Press this button to activate the Scrambler/ Encryption.

- Beep A (1 beep) sounds.

Press this button again to deactivate Scrambler/ Encryption.

- Beep B (2 beeps) sounds.

Note:

- ◆ To use Encryption function, the settings by your dealer are required.
- ◆ If the Scrambler/Encryption function is used in a mixed channel to set Scrambler/ Encryption function to On/Off, the changes will be applied to the mode set in Transmit Mode.

Speaker Attenuation

Temporarily reduce the volume level of the speaker of the transceiver and speaker/ microphone.

Press this button to change the Speaker Attenuation On or Off.

Note:

- ◆ The status of this function (enabled or disabled) is retained even if the transceiver is turned OFF.

Squelch Off

On Digital mode, press this button to deactivate RAN signaling. Press the button again to return to normal operation. Squelch will open with any NXDN signals received regardless of the RAN settings.

On Analog mode, press this button, the squelch is open and the transceiver unmutes the speaker. Press this button again to return to normal operation.

Squelch Off Momentary

On Digital mode, press and hold this button to deactivate RAN signaling. Release the button to return to normal operation. Squelch will open with any NXDN signals received regardless of the RAN settings.

On Analog mode, press and hold this button, the squelch is open and the transceiver unmutes the speaker. Release this button to return to normal operation.

Super Lock

This function prevents the user from mistakenly changing channels or stopping scan through unexpected operation. When the transceiver is locked, changing of zone or channel is not allowed even if the selector knob is turned to another zone or channel.

Press and hold this button for 4 seconds activates the Super Lock function.

- The following Knob/Button function can still be used while Super Lock mode is activated:
 - **Knob function:** Power switch/ Volume control
 - **Button function:** PTT, Calling Alert, Squelch Off, Squelch Off Momentary, Monitor, Monitor Momentary, and Second PTT *.
- The transceiver will not be able to enter the following modes while in the Super Lock mode:
 - Self-programming Mode, Channel Confirmation Mode, Button Function Programming Mode, All Reset Mode, and VOX Function Setup Mode *.

Note:

- ◆ *: “Second PTT” and “VOX Function Setup Mode” can be activated by your dealer.
 - ◆ The status of this function (enabled or disabled) is retained even if the transceiver is turned OFF.
-

To deactivate Super Lock

Turn OFF the transceiver, and press and hold the **PTT** switch and **Side 2** button while turning ON the transceiver. Once an LED lights yellow, release the **PTT** switch and **Side 2** button within 2 seconds.

- Beep B (2 beeps) sounds and restarts in normal mode.

Zone Down

Press and hold this button to decrease the zone number in steps of 1.

Zone Up

Press and hold this button to increase the zone number in steps of 1.

Channel Down

Press and hold this button to decrease the channel number in steps of 1.

Channel Up

Press and hold this button to increase the channel number in steps of 1.

OTHER PROGRAM FUNCTIONS

The following program functions are set by your dealer.

SECOND PTT

By pressing this button, you can use the same operation as **PTT** switch to move to a different channel (Second PTT Channel) from the standby channel and transmit.

- Second PTT Channel can be set for each zone.
- When starting transmission on the Second PTT Channel, the Second Channel Tone will sound.

Note:

- ◆ Combined with Second Channel Scan, the transceiver scanning the standby channel and Second PTT Channel at any time.
 - ◆ To use the Second Channel Scan, the Scan Type must be set to “Second Channel”.
-

CW MESSAGE

Allows you to send the configured CW Message.

Press this button to send configured CW Message (Morse code).

FIXED VOLUME

Allows you to change the volume level of the beep tone.

Press this button to change the volume level Low, High, or Off (tone Off).

RX/TX FREQUENCY SCAN

This function is for the repeater operation. The transceiver can receive uplink signal directly even outside the repeater coverage area.

Press or hold this button to activate scan on the channel.

- The LED blinks blue and Beep A (1 beep) sounds.

In RX/TX Frequency Scan mode, press or hold this button to end scan.

- Beep B (2 beeps) sounds and the LED will stop blinking blue.

ZONE SELECT

Switches the Zone number instead of the Channel number by using the **Selector**.

VOICE OPERATED TRANSMISSION (VOX)

VOX (VOX/ Semi-VOX) operation allows you to transmit hands-free. This feature can be enabled by your dealer. To operate VOX, you must use an optional headset.

VOX Type

VOX: When the voice level to the microphone is higher than the reference level (VOX Gain Level), the transceiver automatically starts transmission.

Semi-VOX: Transmission is started by pressing the **PTT** switch or the button programmed as [**Second PTT**], and transmission continues while speaking, even after the **PTT** switch or the button programmed as [**Second PTT**] is released.

The Semi-VOX function is effective in the following cases.

- Incorrect transmission due to noise.
- Voice at the start of transmission is interrupted.

VOX Function Setup

To activate VOX and set the VOX Gain level, perform the following steps:

- 1 Connect the headset to the transceiver.
 - The VOX function does not activate when a headset is not connected to the accessory terminal of the transceiver.
- 2 With the transceiver power OFF, press and hold the **Side 1** button while turning the transceiver power ON.
- 3 Continue to hold the **Side 1** button until Beep A (1 beep) sounds.
 - The LED lights yellow.
 - When the **Side 1** button is released, the transceiver will announce: Zone number, Channel number, VOX Gain level.
- 4 Use the button below to set VOX function.

VOX function ON/ OFF

Press the **Side 2** button to toggle VOX function ON or OFF for the current zone-channel. When turned ON, Beep A (1 beep) sounds. When turned OFF, Beep B (2 beeps) sounds.

- You can change this setting for each zone and channel (selecting a zone: press and hold the **Side 2**, selecting a channel: rotate the **Selector**).

VOX Gain Level Adjustment

Press the **Side 1** button to set the VOX Gain level, from 1 (least sensitive) to 10 (most sensitive).

VOX/ Semi-VOX Selection

Press and hold the **Side 1** button to toggle VOX type to VOX or Semi-VOX. When Semi-VOX is selected, Beep A (1 beep) sounds. When VOX is selected, Beep B (2 beeps) sounds.

- 5 Press the **PTT** switch to save the settings.
 - Beep A (1 beep) will sound.
 - The transceiver announces the new VOX Gain level.
- 6 Turn the transceiver power OFF and then ON again to activate VOX.

Note:

- ◆ If a headset is connected to the transceiver while the VOX function is switched ON and the VOX Gain level is configured to a higher, more sensitive level, louder received signals may cause the transceiver to start transmission.
 - ◆ If no action is performed for 20 seconds, the transceiver will automatically return to normal operation without changing any settings.
-

VOX Operation

- 1 To transmit, simply speak to the microphone.
- 2 When you finish speaking, transmission ends.

Semi-VOX Operation

- 1 To transmit, press the **PTT** switch or the button programmed as [**Second PTT**].
- 2 Release the **PTT** switch or the button programmed as [**Second PTT**].
- 3 Transmission continues while speaking.
- 4 When you finish speaking, transmission ends.

BACKGROUND OPERATIONS

TIME-OUT TIMER (TOT)

The Time-out Timer prevent callers from using a channel for an extended duration. If you continuously transmit for the duration programmed by your dealer (default is 60 seconds), transmission will stop and an alert tone will sound. To stop the tone, release the **PTT** switch.

BATTERY SAVER

When activated by your dealer, the Battery Saver function decreases the amount of power used after no signal is present and no operations are being performed for specific time periods. When a signal is received or an operation is performed, Battery Saver turns off.

Note:

- ◆ The timing of starting Battery Saver is different between Analog and Digital Mode.
 - ◆ While the Battery Saver is operating, the LED may flash green when receiving a QT/DQT/RAN signal which does not match the QT/DQT/RAN set up in your transceiver.
-

LOW BATTERY WARNING

While operating the transceiver, the Low Battery Warning sounds an alert tone every 30 seconds and the LED blinks red when the battery needs recharged or replaced.

BUSY CHANNEL LOCKOUT (BCL)

When activated by your dealer, BCL prevents you from interfering on a channel that is already in use. Pressing the **PTT** switch will cause a warning tone to sound and the transceiver will not transmit. Release the **PTT** switch to stop the tone.

VOICE ANNOUNCEMENT

An audio voice will be announced.

- When changing the zone and/or channel, the new zone and channel number are announced.
- When changing the function on/ off, the new settings is announced.
 - Encryption
 - Scrambler
 - Home Channel
 - Button Lock
 - Low Transmit Power
 - Scan
 - Speaker Attenuation

ALL RESET MODE

At some point in time, you may desire to reset the transceiver settings to their default values.

The following settings will return to the default values.

- Self-programming Mode
 - Button Function Programming Mode
 - VOX Function Setup Mode
- 1 With the transceiver power OFF, press and hold the **PTT** switch, the **Side 1** button, and the **Side 2** button while turning the transceiver power ON.
 - Continue to hold the buttons, until the LED lights yellow.
 - 2 Release the buttons within 2 seconds.
 - Beep A (1 beep) sounds and returns to normal operation.
 - If the buttons are released before the LED lights yellow or the buttons are released after 2 seconds, All Reset Mode will cancel.

Note:

- ◆ Once the transceiver is programmed by your dealer, the dealer's settings are default instead of the factory's settings at shipment.
-

TROUBLESHOOTING GUIDE

Problem	Solution	Ref. page
Cannot turn the transceiver power ON.	The battery pack may be dead. Recharge or replace the battery pack.	-
	The battery pack may not be installed correctly. Remove the battery pack and install it again.	5
Battery power dies shortly after charging.	The battery pack life is finished. The battery pack may need replacing.	-
Cannot talk to or hear other members in your group.	Make sure you are using the same frequency and QT/DQT or RAN settings as the other group members.	29 32
	Other group members may be using Scrambler/ Encryption. Turn on your transceiver's Scrambler/ Encryption.	41
	When using Reserved Group function, the Reserved Group ID may not match. Make sure you are using the same Reserved Group ID as the other group members.	20
Other voices (besides group members) are present on the channel.	Change the QT/DQT or RAN settings. Make sure all group members change the settings on their transceivers to match the new QT/ DQT or RAN settings.	29 32
Buttons and Selector do not function.	Button Lock may be activated. Press or hold the button programmed as [Button Lock] to deactivate Button Lock.	37
	Super Lock may be activated, hence once turn OFF the transceiver. Press and hold the PTT switch and Side 2 button while turning ON the transceiver to deactivate Super Lock.	42
Transceiver is malfunctioning for no apparent reason.	Reset the transceiver as described on.	48
Cannot enter the setup mode.	These operations may not be available depending on dealer settings. Consult your dealer.	-

SPECIFICATIONS

Transmit Power	NX-P1200NV NX-P1200AV NX-P1300NU NX-P1300AU	5 / 4 / 1 W
	NX-P1202AV NX-P1302AU	2 / 1 W
Audio Output	1 W / 12 Ω (Internal Speaker) 500 mW / 8 Ω (External Output)	
Operating Voltage	7.5 V DC \pm 20 %	
Operating Temperature Range	-30°C (-22°F)~ +60°C (+140°F)	
Frequency Stability	\pm 0.5 ppm	
Antenna Impedance	50 Ω	
Battery Life with KNB-45L (Calculated using 5% transmit time, 5% receive time, and 90% standby time.)	11 hours	
Dimensions (W x H x D) (Projections not included with KNB-45L)	54 x 123 x 33.5 mm (2.13 x 4.84 x 1.32 inches)	
Weight with KNB-45L	280 g (9.88 oz)	

KENWOOD

© 2020 JVCKENWOOD Corporation